



# 目 录

一、运输作业组织与管理模块..... 2

二、仓储与配送作业组织与管理模块..... 34

三、国际物流作业组织与管理模块..... 150

四、 快递物流作业组织与管理模块.....	213
-----------------------	-----

湖南商务职业技术学院物流管理专业学生技能考核题库

## 一、运输作业组织与管理模块

○

○

○

--	--	--

○

○

--	--	--	--	--

## ( ) 任务描述

- :
- 
-





<input type="checkbox"/> <input type="checkbox"/>				<input type="checkbox"/> <input type="checkbox"/>				
<input type="checkbox"/> <input type="checkbox"/>								
						<input type="checkbox"/> <input type="checkbox"/> <input type="checkbox"/> <input type="checkbox"/>		





( ) 任务描述:

- 
- 
- 







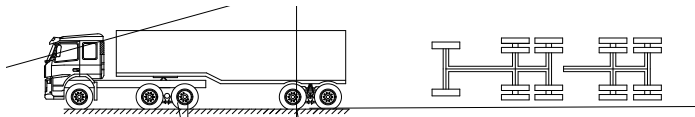

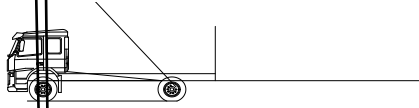
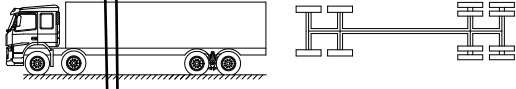
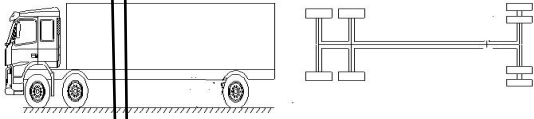
( ) 任务描述:







○

○

○

○

○



( ) 任务描述



**D**

<input type="checkbox"/> <input type="checkbox"/>			<input type="checkbox"/> <input type="checkbox"/>						
<input type="checkbox"/> <input type="checkbox"/>									
						<input type="checkbox"/> <input type="checkbox"/> <input type="checkbox"/> <input type="checkbox"/>			





**2**

**3**

**4**



( ) 任务描述

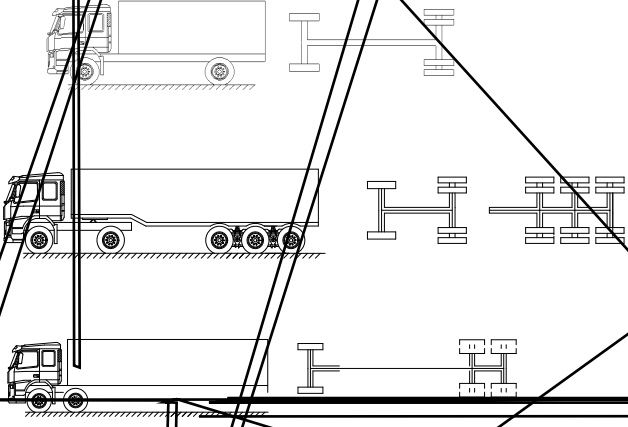
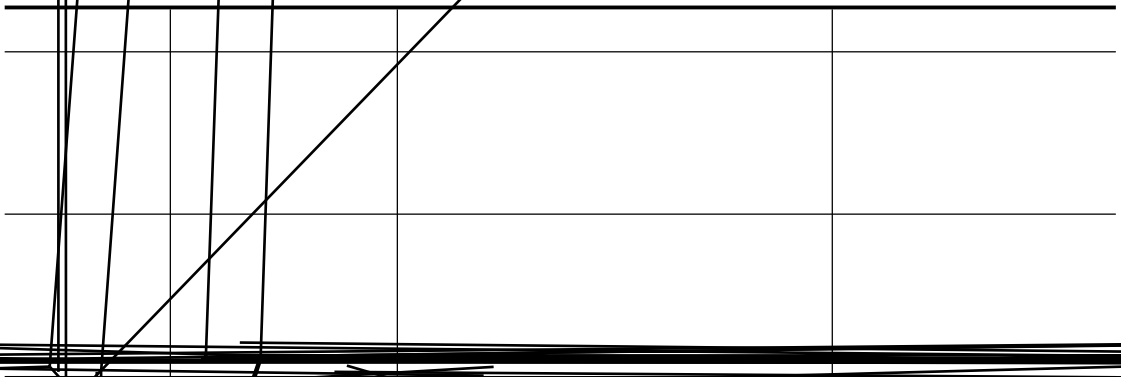







**( ) 任务描述**

- 
- 
- 
- 
- 





( ) 任务描述



○



○

Sailing Schedule from : Shenzhen,Shenzhen,Guangdong,China

To : Los Angeles,Los Angeles,CA,United States

Origin City : Shenzhen,Shenzhen,Guangdong,China

CY/DOOR

Destination City : Los Angeles,Los Angeles,CA,United States

CY/DOOR

序列号	航线	船名	航次	截关时间	装货港	预计离港时间	实际离港时间	卸货港
1	YPSW	YM UNISON	59E	2016-04-22 17:00	Yantian	2016-04-25		Los Angeles
2	SEA	NORTHERN JAVELIN	002E	2016-04-23 12:00	Yantian	2016-04-27		Long Beach
3	AAS2	CMA CGM LIBRA	095TXE	2016-04-25 16:00	Yantian	2016-04-28		Long Beach
4	YPSW	YM UBIQUITY	22E	2016-04-29 17:00	Yantian	2016-05-02		Los Angeles
5	SEA	C SCL PUSAN	117E	2016-04-30 12:00	Yantian	2016-05-04		Long Beach
6	AAS2	CMA CGM COLUMBA	097TXE	2016-05-02 16:00	Yantian	2016-05-05		Long Beach
7	SEA	COSCO NINGBO	069W	2016-05-06 11:00	Yantian	2016-05-08		Long Beach
8	YPSW	YM JIREBY...	50E	2016-05-06 17:00	Yantian	2016-05-09		Los Angeles
9	SEA	COSCO EXCELLENCE	027E	2016-05-07 12:00	Yantian	2016-05-11		Long Beach
10	AAS2	CMA CGM CENTAURUS	099TXE	2016-05-09 16:00	Yantian	2016-05-12		Long Beach
11	YPSW	YM MASCULINITY	32E	2016-05-13 17:00	Yantian	2016-05-16		Los Angeles
12	SEA	HONG KONG BRIDGE	039E	2016-05-14 12:00	Yantian	2016-05-18		Long Beach
13	AAS2	CMA CGM THALASSA	101TXE	2016-05-16 16:00	Yantian	2016-05-19		Long Beach



干货箱



	箱体内部尺寸			箱体内容积及载重量		箱门开度尺寸	
	L	W	H	Cu	P	W	H
20'	5898	2352	2393	33.2	21740/28230#	2340	2280
40'	12032	2352	2393	67.7	26630	2340	2280
HC	12032	2352	2698	76.3	26520	2340	2585

冷藏箱



	箱体内部尺寸			箱体内容积及载重量	
	L	W	H	Cu	P
20'	5444	2284	2267	28.5	21135/27160#
40'	11583	2284	2250	58.7	26580
HC	11583	2286	2556	67.9	26380

开顶箱



	箱体内部尺寸			箱体内容积及载重量	
	L	W	P	Cu	P
20'	5900	2330	2337	32.6	21740
40'	12025	2330	2337	65.8	26410

○

○

( ) 实施条件

( ) 考核时量

( ) 评分细则

1





( ) 任务描述



		<input type="checkbox"/>	<input type="checkbox"/>	<input type="checkbox"/>	<input type="checkbox"/>

<input type="checkbox"/>		<input type="checkbox"/>					
<input type="checkbox"/>		<input type="checkbox"/>					



( ) 实施条件

( ) 考核时量

( ) 评分细则









# 产品运输单

---



- 
- 
- 
- 
- 
- 
- 
- 





80				









# 产品运输单

---



- 
- 
- 
- 
- 
- 
- 
-













## 产品运输单

---



- 
- 
- 
- 
- 
- 
- 
-













# 产品运输单

---



- 
- 
- 
- 
- 
- 
- 
-





















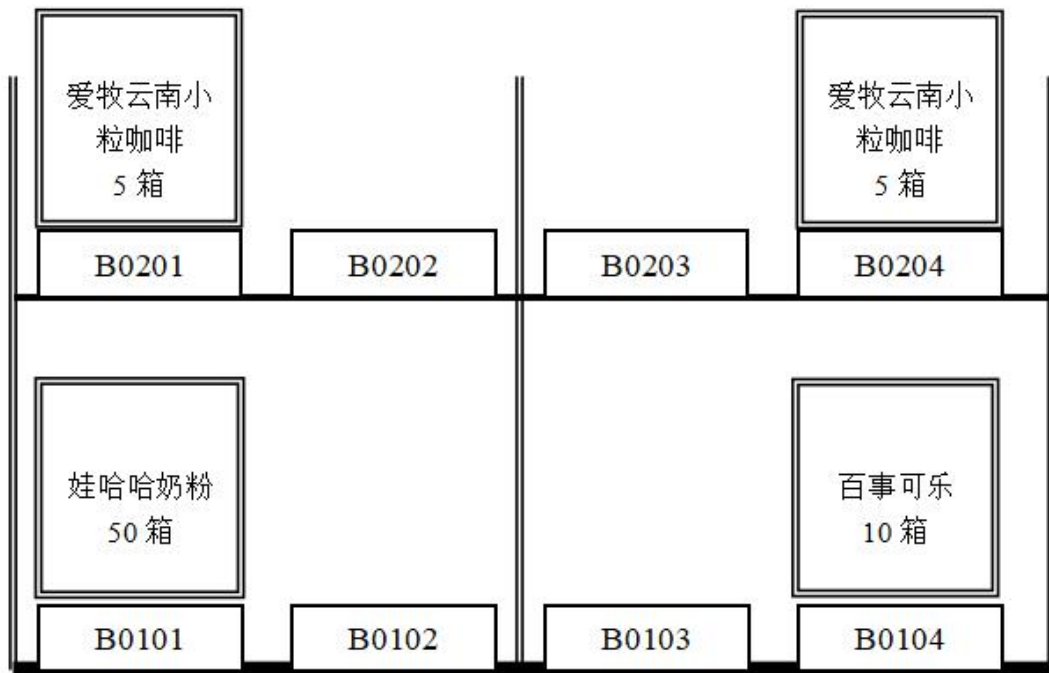

## 产品运输单













# 产品运输单

---



- 
- 
- 
- 
- 
- 
- 
- 
- 













# 产品运输单

---



- 
- 
- 
- 
- 
- 
- 
-









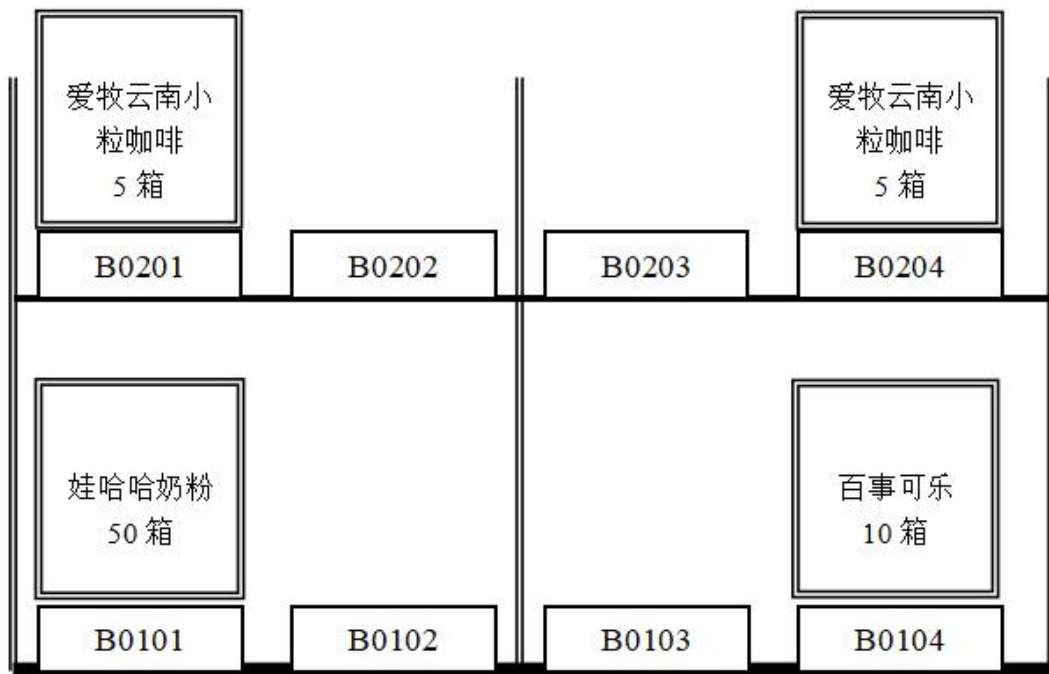

# 产品运输单

---



- 
- 
- 
- 
- 
- 
- 
- 
-











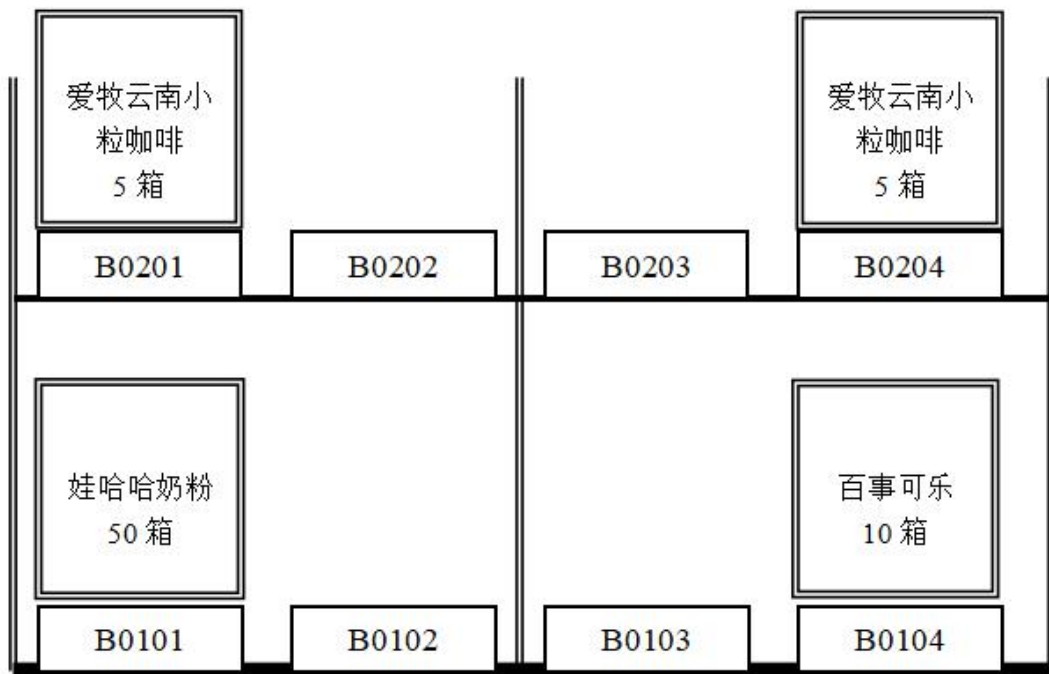

# 产品运输单

---



- 
- 
- 
- 
- 
- 
- 
- 







○

---



---



---

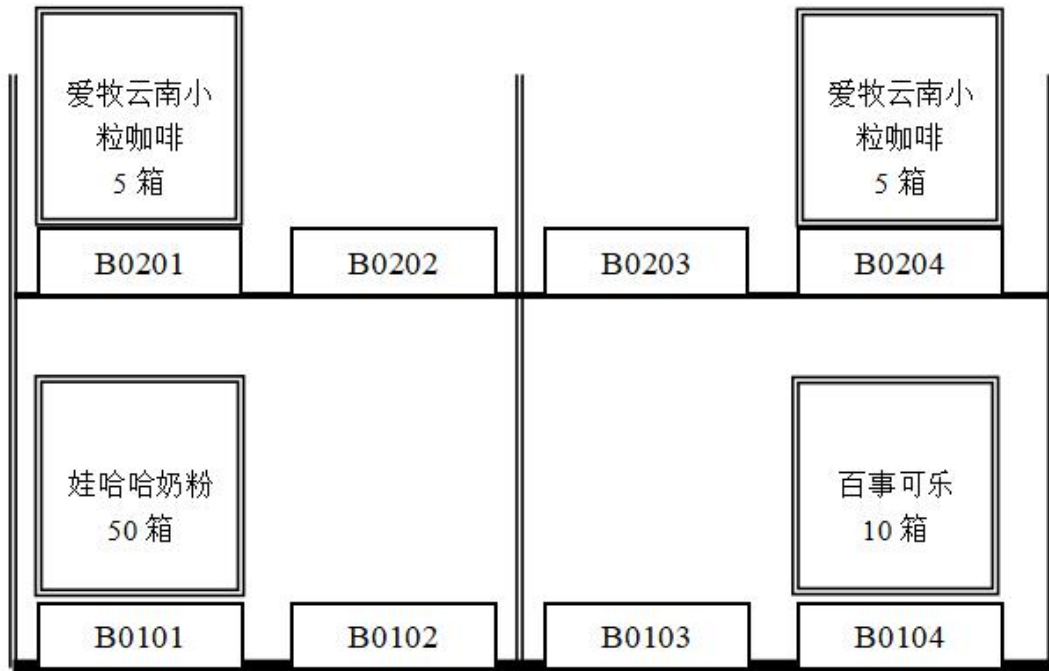

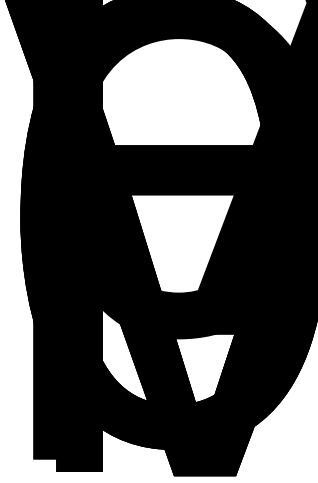

**W.**





---

--	--	--	--	--	--

---



---

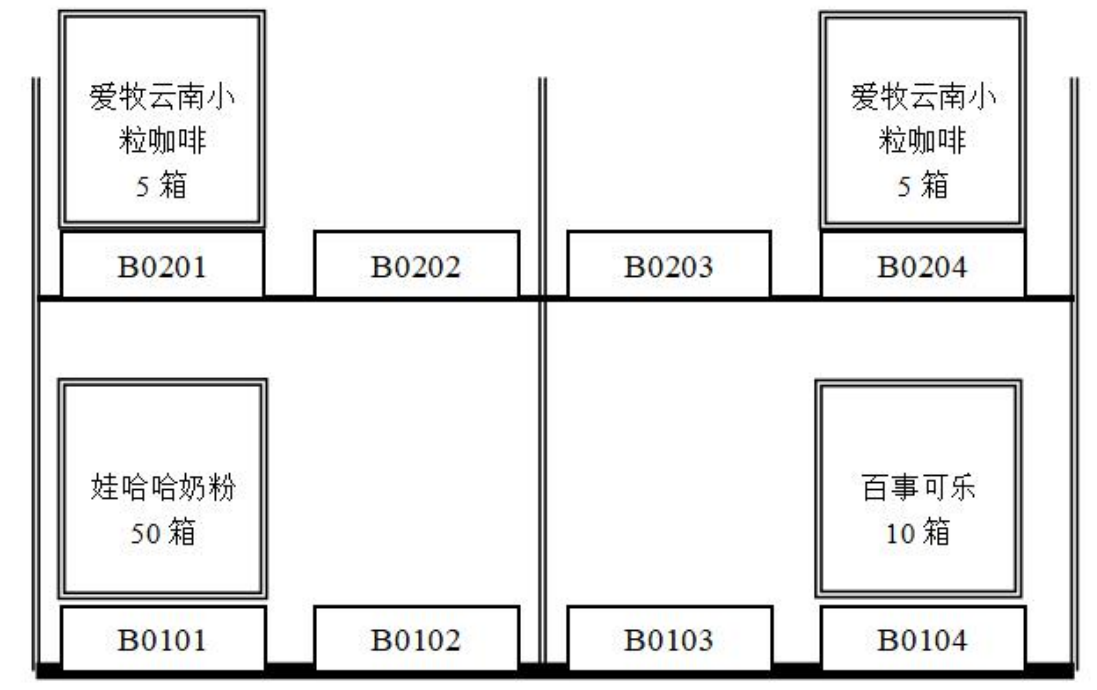

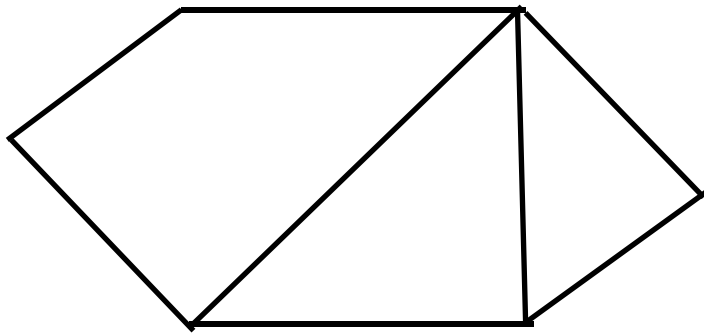





---



---







**1**

---

		---	---		

---

		---	---		

---

--	--

--- ---





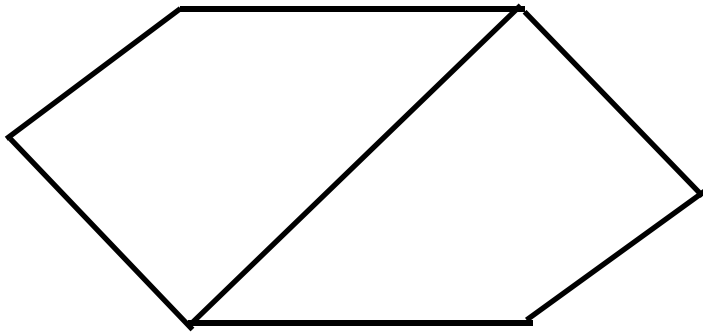



**1**

---



--	--	--	--	--	--

---



---

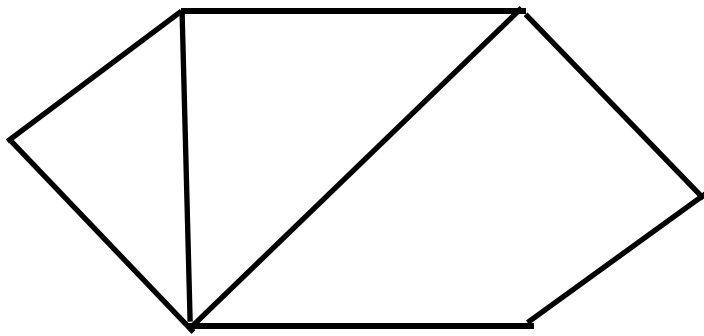











○

○













○

○











○

○













○

○

--	--











○

○







### 三、国际物流作业组织与管理模块



○



---

---

---

---





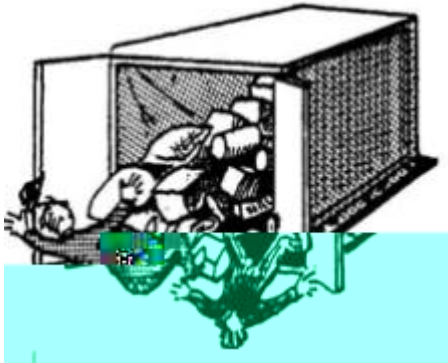
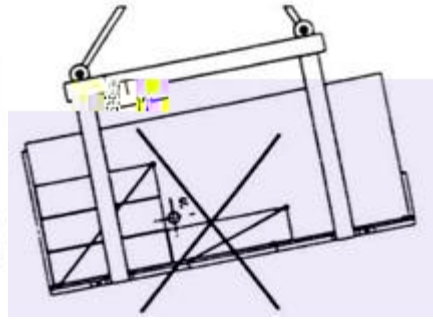





○

船公司 Carrier	船名/航次 Voyage	服务代码 Service	航线 Lane	装船港/卸船港 Load/Unload Port	启-达日期 ETD-ETA	天 Day	挂港 Port
MSC 地中海航运	MASTER HQ409E		中国-港澳台	HONG KONG 香港 KAOHSIUNG 高雄	02/25(二) 03/15(六)	18	香港 高雄
NYK 日本邮船	ITALIAN EXPRES S/024		中国-东南亚	HONG KONG 香港 BANGKOK 曼谷	02/25(二) 03/02(日)	5	香港 曼谷
CMA-CGM 达飞轮船	CMA CGM GEMINI TXA49E		中国-非洲	XIAMEN 厦门 DURBAN 德班	02/25(二) 03/27(四)	30	厦门 德班
KLINE 川崎汽船	HYUNDAI PLATINU M/004W		中国-中南美	SHANGHAI 上海 PARANAGUA 巴拉那瓜	02/25(二) 04/09(三)	43	上海 巴拉那瓜
DMS 达茂轮船	COSCO KAOHSIUNG G/GFS46E		中国-澳新	HONG KONG 香港 NOUMEA 努美阿	02/25(二) 04/02(三)	36	香港 努美阿
RCL 地中海航运	NOTA PERMASAN VPM114		中国-中东/ 波斯湾/印巴	QINGDAO 青岛 MADRAS 马德拉斯	02/28(五) 03/18(二)	18	青岛 马德拉斯
ZIM 以星轮船	KUO HUNG 311	CHINA_VIETN AM(CVX)	中国-港澳台	NINGBO 宁波 HONG KONG 香港	02/25(二) 03/15(六)	18	宁波 香港
SAFMARINE 比利时报航	HEIKE P 1404		中国-非洲	KAOHSIUNG 高雄 MINDELO	02/25(二) 04/05(六)	39	高雄 明德洛
CSAV 南兴轮船	CAP SAN NICOLA S/01409		中国-中南美	SHANGHAI 上海 RIO GRANDE 里奥格兰德	02/25(二) 04/07(一)	41	上海 里奥格兰德
OOCL 东方海外	DRESDEN EXPRES S/16808	Pacific Atl antic (PAX)	中国-澳东	SHANGHAI 上海 HALIFAX 哈利法克斯	02/25(二) 04/14(一)	48	上海 哈利法克斯



○  
○

BEIJING	CN		BJ\$
Y. RENMINBI	CNY		KGS
2020	100	8	120.00
		8	75.00
		80	88.74
		100	82.74
		100	82.29



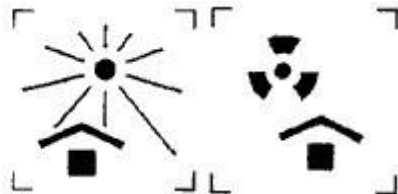

○





○

○







---

---

---

---

---

---

---

---

**集装箱设备交接单  
EQUIPMENT INTERCHANGE RECEIPT**

**OUT 出场**

No.

用箱人/运箱人(CNTR. USER/AULIER)		提箱地点(PLACE OF DELIVERY)	
发往地点(DELIVERED TO)		返回/收箱地点(PLACE OF RETURN)	
船名/航次(VESSEL/VOYAGE No.)		集装箱号(CNTR. No.)	尺寸/类型(SIZE/TYPER)
船东/代理(SHIP/AGENCY)		承运人(CNTR. OPTR)	
箱号(B/L No.)	设备类型(EQUIP. TYPE)	箱封号(SEAL No.)	免费期限(FREE TIME PERIOD)
货物(CARGO W.)		出场目的/状态(PPS OF GATE-OUT/STATUS)	进场目的/状态(PPS OF GATE-IN/STATUS)
		出场日期(TIME-OUT) 月 日 时	
出场检查记录(INSPECTION AT THE TIME OF INTERCHANGE)			
普通集装箱(GP. CNTR.)	冷藏集装箱(REF. CNTR.)	特种集装箱(SPL. CNTR.)	发电机(GEN. SET)
<input type="checkbox"/> 正常(SOUND) <input type="checkbox"/> 异常(DEFFECTIVE)	<input type="checkbox"/> 正常(SOUND) <input type="checkbox"/> 异常(DEFFECTIVE)	设定温度(SET) 记录温度(RECORDED)	<input type="checkbox"/> 正常(SOUND) <input type="checkbox"/> 异常(DEFFECTIVE)
损坏记录及代号(DAMAGE CODE)			
除列明者外, 集装箱设备交接单时完好无损, 箱封完整无漏。 ALL EQUIPMENT INTERCHANGED IN SOUND CONDITION AND SEAL INTACT UNLESS OTHERWISE STATED			
用箱人/运箱人签字 (CONTAINER USER/AULIER'S SIGNATURE)	码头/堆场值班员签字 (TERMINAL/DEPOT CLERK'S SIGNATURE)		用箱人/运箱人盖章 (CONTAINER USER/AULIER'S SIGNATURE)
月 日	年 月 日		年
GB/T 14541-1996 格式印制			













--	--	--	--	--	--











**WOLFE**





--	--	--



--	--	--	--	--	--





--	--	--	--	--	--

--	--	--	--	--	--	--	--

○













	* \	









○

--	--	--











--	--	--	--	--	--

○

○

○



○







#### 四、 快递物流作业组织与管理模块























--	--	--	--	--	--

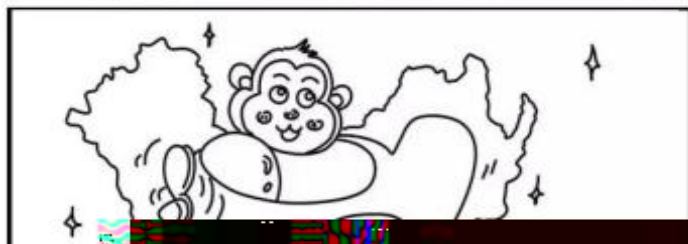
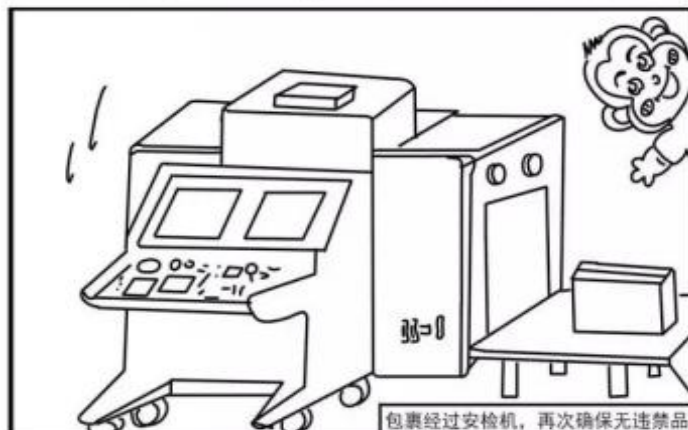
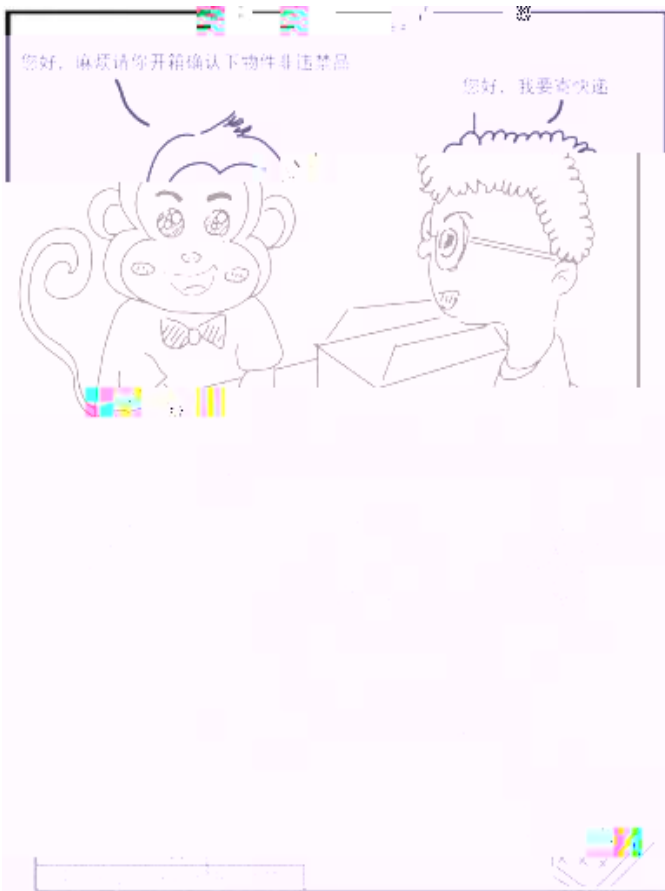



--	--	--	--	--	--

2018  
10/18













---





--	--	--	--	--	--



[想知道:中国成都理工大学校园快递具体在哪? 百度知道](#)

3个回答 - 提问时间: 2014年02月10日

**最佳答案** [匿名用户](#) 顺丰后面，圆通，中通，顺丰在图书馆下面，常用的就是这几个。

[百度知道](#) 知道 快递 成都理工大学 快递 快递 快递 快递 快递 快递



















--	--	--	--



















--	--	--	--















































































<hr/>
-------

